



# Micropower, Low Noise Precision Voltage References with Shutdown

## ADR390/ADR391/ADR392/ADR395

### FEATURES

Compact TSOT-23-5 packages

Low temperature coefficient

B grade: 9 ppm/°C

A grade: 25 ppm/°C

Initial accuracy

B grade: ±4 mV maximum

A grade: ±6 mV maximum

Ultralow output noise: 5 µV p-p (0.1 Hz to 10 Hz)

Low dropout: 300 mV

Low supply current

3 µA maximum in shutdown

120 µA maximum in operation

No external capacitor required

Output current: 5 mA

Wide temperature range

−40°C to +125°C

### APPLICATIONS

Battery-powered instrumentations

Portable medical instrumentations

Data acquisition systems

Industrial process controls

Automotive

### GENERAL DESCRIPTION

The ADR390, ADR391, ADR392, and ADR395 are precision 2.048 V, 2.5 V, 4.096 V, and 5 V band gap voltage references that feature low power and high precision in a tiny footprint. Using ADI's patented temperature drift curvature correction techniques, the ADR39x references achieve a low 9 ppm/°C of temperature drift in the TSOT package.

The ADR39x family of micropower, low dropout voltage references provides a stable output voltage from a minimum supply of 300 mV above the output. Their advanced design eliminates the need for external capacitors, which further reduces board space and system cost. The combination of low power operation, small size, and ease of use makes the ADR39x precision voltage references ideally suited for battery-operated applications.

### Rev. E

Information furnished by Analog Devices is believed to be accurate and reliable. However, no responsibility is assumed by Analog Devices for its use, nor for any infringements of patents or other rights of third parties that may result from its use. Specifications subject to change without notice. No license is granted by implication or otherwise under any patent or patent rights of Analog Devices. Trademarks and registered trademarks are the property of their respective owners.

### FUNCTIONAL BLOCK DIAGRAM

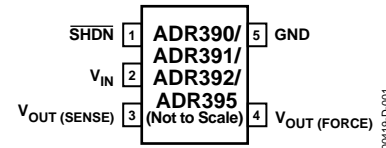

Figure 1. 5-Lead TSOT (UJ Suffix)

Table 1.

| Model   | V <sub>OUT</sub> (V) | Temperature Coefficient (ppm/°C) | Accuracy (mV) |
|---------|----------------------|----------------------------------|---------------|
| ADR390B | 2.048                | 9                                | ±4            |
| ADR390A | 2.048                | 25                               | ±6            |
| ADR391B | 2.5                  | 9                                | ±4            |
| ADR391A | 2.5                  | 25                               | ±6            |
| ADR392B | 4.096                | 9                                | ±5            |
| ADR392A | 4.096                | 25                               | ±6            |
| ADR395B | 5.0                  | 9                                | ±5            |
| ADR395A | 5.0                  | 25                               | ±6            |

Contact Analog Devices, Inc. for other voltage options.

## TABLE OF CONTENTS

|   |    |
|---|----|
| ADR390—Specifications .....               | 3  |
| ADR391—Specifications .....               | 4  |
| ADR392—Specifications .....               | 5  |
| ADR395—Specifications .....               | 6  |
| Absolute Maximum Ratings.....             | 7  |
| Thermal Resistance .....                  | 7  |
| ESD Caution.....                          | 7  |
| Terminology .....                         | 8  |
| Typical Performance Characteristics ..... | 9  |
| Theory of Operation .....                 | 16 |
| Applications.....                         | 17 |
| Basic Voltage Reference Connection .....  | 17 |
| Outline Dimensions .....                  | 19 |
| Ordering Guide.....                       | 19 |

## REVISION HISTORY

### 4/04—Data Sheet Changed from Rev. D to Rev. E

|                                       |   |
|---------------------------------------|---|
| Changes to ADR390—Specifications..... | 3 |
| Changes to ADR391—Specifications..... | 4 |
| Changes to ADR392—Specifications..... | 5 |
| Changes to ADR395—Specifications..... | 6 |

### 4/04—Data Sheet Changed from Rev. C to Rev. D

|   |           |
|---|-----------|
| Updated Format.....   | Universal |
| Changes to Title .....  | 1         |
| Changes to Features .....                                       | 1         |
| Changes to Applications .....                                   | 1         |
| Changes to General Description .....                            | 1         |
| Changes to Table 1.....   | 1         |
| Changes to ADR390—Specifications.....                           | 3         |
| Changes to ADR391—Specifications.....                           | 4         |
| Changes to ADR392—Specifications.....                           | 5         |
| Changes to ADR395—Specifications.....                           | 6         |
| Changes to Absolute Maximum Ratings.....                        | 7         |
| Changes to Thermal Resistance.....                              | 7         |
| Moved ESD Caution .....   | 7         |
| Changes to Figure 3, Figure 4, Figure 7, and Figure 8.....      | 9         |
| Changes to Figure 11, Figure 12, Figure 13, and Figure 14 ..... | 10        |
| Changes to Figure 15, Figure 16, Figure 19, and Figure 20 ..... | 11        |
| Changes to Figure 23 and Figure 24.....                         | 12        |
| Changes to Figure 27.....                                       | 13        |
| Changes to Ordering Guide .....                                 | 19        |
| Updated Outline Dimensions.....                                 | 19        |

### 10/02—Data Sheet Changed from Rev. B to Rev. C

|  |           |
|--|-----------|
| Add parts ADR392 and ADR395 .....  | Universal |
| Changes to Features .....  | 1         |
| Changes to General Description .....   | 1         |
| Additions to Table I.....  | 1         |
| Changes to Specifications.....   | 2         |
| Changes to Ordering Guide .....  | 4         |
| Changes to Absolute Maximum Ratings.....   | 4         |
| New TPCs 3, 4, 7, 8, 11, 12, 15, 16, 19, and 20.....                               | 6         |
| New Figures 4 and 5.....   | 13        |
| Deleted A Negative Precision Reference<br>without Precision Resistors Section..... | 13        |
| Edits to General-Purpose Current Source Section .....                              | 13        |
| Updated Outline Dimensions.....  | 15        |

### 5/02—Data Sheet Changed from Rev. A to Rev. B

|                          |           |
|--------------------------|-----------|
| Edits to Layout .....    | Universal |
| Changes to Figure 6..... | 13        |

## ADR390—SPECIFICATIONS

Electrical Characteristics,  $V_{IN} = 2.5\text{ V to }15\text{ V}$ ,  $T_A = 25^\circ\text{C}$ , unless otherwise noted.

Table 2.

| Parameter                        | Symbol                         | Conditions   | Min   | Typ   | Max   | Unit                  |                              |             |  |     |               |
|----------------------------------|--------------------------------|--|-------|-------|-------|-----------------------|------------------------------|-------------|--|-----|---------------|
| OUTPUT VOLTAGE                   | $V_O$                          | A Grade  | 2.042 | 2.048 | 2.054 | V                     |                              |             |  |     |               |
|                                  | $V_O$                          | B Grade  | 2.044 | 2.048 | 2.052 | V                     |                              |             |  |     |               |
| INITIAL ACCURACY                 | $V_{OERR}$                     | A Grade  |       |       | 6     | mV                    |                              |             |  |     |               |
|                                  | $V_{OERR}$                     | A Grade  |       |       | 0.29  | %                     |                              |             |  |     |               |
|                                  | $V_{OERR}$                     | B Grade  |       |       | 4     | mV                    |                              |             |  |     |               |
|                                  | $V_{OERR}$                     | B Grade  |       |       | 0.19  | %                     |                              |             |  |     |               |
| TEMPERATURE COEFFICIENT          | $TCV_O$                        | A Grade, $-40^\circ\text{C} < T_A < +125^\circ\text{C}$  |       |       | 25    | ppm/ $^\circ\text{C}$ |                              |             |  |     |               |
|                                  |                                | B Grade, $-40^\circ\text{C} < T_A < +125^\circ\text{C}$  |       |       | 9     | ppm/ $^\circ\text{C}$ |                              |             |  |     |               |
| SUPPLY VOLTAGE HEADROOM          | $V_{IN} - V_O$                 |  | 300   |       |       | mV                    |                              |             |  |     |               |
| LINE REGULATION                  | $\Delta V_O / \Delta V_{IN}$   | $V_{IN} = 2.5\text{ V to }15\text{ V}$ , $-40^\circ\text{C} < T_A < +125^\circ\text{C}$                          |       | 10    | 25    | ppm/V                 |                              |             |  |     |               |
| LOAD REGULATION                  | $\Delta V_O / \Delta I_{LOAD}$ | $I_{LOAD} = 0\text{ mA to }5\text{ mA}$ , $-40^\circ\text{C} < T_A < +85^\circ\text{C}$ , $V_{IN} = 3\text{ V}$  |       |       | 60    | ppm/mA                |                              |             |  |     |               |
|                                  |                                | $I_{LOAD} = 0\text{ mA to }5\text{ mA}$ , $-40^\circ\text{C} < T_A < +125^\circ\text{C}$ , $V_{IN} = 3\text{ V}$ |       |       | 140   | ppm/mA                |                              |             |  |     |               |
| QUIESCENT CURRENT                | $I_{IN}$                       | No Load<br>$-40^\circ\text{C} < T_A < +125^\circ\text{C}$  |       |       | 120   | $\mu\text{A}$         |                              |             |  |     |               |
|                                  |                                |  |       |       | 140   | $\mu\text{A}$         |                              |             |  |     |               |
| VOLTAGE NOISE                    | $e_{N\text{ p-p}}$             | 0.1 Hz to 10 Hz  |       | 5     |       | $\mu\text{V p-p}$     |                              |             |  |     |               |
| TURN-ON SETTLING TIME            | $t_R$                          |  |       | 20    |       | $\mu\text{s}$         |                              |             |  |     |               |
| LONG-TERM STABILITY <sup>1</sup> | $\Delta V_O$                   | 1, 000 Hours   |       | 50    |       | ppm                   |                              |             |  |     |               |
| OUTPUT VOLTAGE HYSTERESIS        | $\Delta V_{O\_HYS}$            |  |       | 100   |       | ppm                   |                              |             |  |     |               |
| RIPPLE REJECTION RATIO           | RRR                            | $f_{IN} = 60\text{ kHz}$   |       | 80    |       | dB                    |                              |             |  |     |               |
| SHORT CIRCUIT TO GND             | $I_{SC}$                       | $V_{IN} = 5\text{ V}$  |       | 25    |       | mA                    |                              |             |  |     |               |
|                                  |                                | $V_{IN} = 15\text{ V}$   |       | 30    |       | mA                    |                              |             |  |     |               |
| SHUTDOWN PIN                     |                                |  | 2.4   |       |       |                       |                              |             |  |     |               |
|                                  |                                |  |       |       |       |                       | Shutdown Supply Current      | $I_{SHDN}$  |  | 3   | $\mu\text{A}$ |
|                                  |                                |  |       |       |       |                       | Shutdown Logic Input Current | $I_{LOGIC}$ |  | 500 | nA            |
|                                  |                                |  |       |       |       |                       | Shutdown Logic Low           | $V_{INL}$   |  | 0.8 | V             |
| Shutdown Logic High              | $V_{INH}$                      |  |       |       | V     |                       |                              |             |  |     |               |

<sup>1</sup> The long-term stability specification is noncumulative. The drift subsequent 1,000 hour periods is significantly lower than in the first 1,000 hour period.

# ADR390/ADR391/ADR392/ADR395

## ADR391—SPECIFICATIONS

Electrical characteristics,  $V_{IN} = 2.8\text{ V to }15\text{ V}$ ,  $T_A = 25^\circ\text{C}$ , unless otherwise noted.

Table 3.

| Parameter                        | Symbol  | Conditions   | Min   | Typ | Max   | Unit                  |
|----------------------------------|---|--|-------|-----|-------|-----------------------|
| OUTPUT VOLTAGE                   | $V_O$   | A Grade  | 2.494 | 2.5 | 2.506 | V                     |
|                                  | $V_O$   | B Grade  | 2.496 | 2.5 | 2.504 | V                     |
| INITIAL ACCURACY                 | $V_{OERR}$  | A Grade  |       |     | 6     | mV                    |
|                                  | $V_{OERR}$  | A Grade  |       |     | 0.24  | %                     |
|                                  | $V_{OERR}$  | B Grade  |       |     | 4     | mV                    |
|                                  | $V_{OERR}$  | B Grade  |       |     | 0.16  | %                     |
| TEMPERATURE COEFFICIENT          | $TCV_O$   | A Grade, $-40^\circ\text{C} < T_A < +125^\circ\text{C}$  |       |     | 25    | ppm/ $^\circ\text{C}$ |
|                                  |   | B Grade, $-40^\circ\text{C} < T_A < +125^\circ\text{C}$  |       |     | 9     | ppm/ $^\circ\text{C}$ |
| SUPPLY VOLTAGE HEADROOM          | $V_{IN} - V_O$                                      |  | 300   |     |       | mV                    |
| LINE REGULATION                  | $\Delta V_O / \Delta V_{IN}$                        | $V_{IN} = 2.8\text{ V to }15\text{ V}$ , $-40^\circ\text{C} < T_A < +125^\circ\text{C}$                          |       | 10  | 25    | ppm/V                 |
| LOAD REGULATION                  | $\Delta V_O / \Delta I_{LOAD}$                      | $I_{LOAD} = 0\text{ mA to }5\text{ mA}$ , $-40^\circ\text{C} < T_A < +85^\circ\text{C}$ , $V_{IN} = 3\text{ V}$  |       |     | 60    | ppm/mA                |
|                                  |   | $I_{LOAD} = 0\text{ mA to }5\text{ mA}$ , $-40^\circ\text{C} < T_A < +125^\circ\text{C}$ , $V_{IN} = 3\text{ V}$ |       |     | 140   | ppm/mA                |
| QUIESCENT CURRENT                | $I_{IN}$  | No Load  |       |     | 120   | $\mu\text{A}$         |
|                                  |   | $-40^\circ\text{C} < T_A < +125^\circ\text{C}$   |       |     | 140   | $\mu\text{A}$         |
| VOLTAGE NOISE                    | $e_{N\text{ p-p}}$                                  | 0.1 Hz to 10 Hz  |       | 5   |       | $\mu\text{V p-p}$     |
| TURN-ON SETTLING TIME            | $t_R$   |  |       | 20  |       | $\mu\text{s}$         |
| LONG-TERM STABILITY <sup>1</sup> | $\Delta V_O$  | 1,000 Hours  |       | 50  |       | ppm                   |
| OUTPUT VOLTAGE HYSTERESIS        | $\Delta V_{O\_HYS}$                                 |  |       | 100 |       | ppm                   |
| RIPPLE REJECTION RATIO           | RRR   | $f_{IN} = 60\text{ kHz}$   |       | 80  |       | dB                    |
| SHORT CIRCUIT TO GND             | $I_{SC}$  | $V_{IN} = 5\text{ V}$  |       | 25  |       | mA                    |
|                                  |   | $V_{IN} = 15\text{ V}$   |       | 30  |       | mA                    |
| SHUTDOWN PIN                     | $I_{SHDN}$<br>$I_{LOGIC}$<br>$V_{INL}$<br>$V_{INH}$ |  | 2.4   |     | 3     | $\mu\text{A}$         |
|                                  |   |  |       |     | 500   | nA                    |
|                                  |   |  |       |     | 0.8   | V                     |
|                                  |   |  |       |     |       | V                     |

<sup>1</sup> The long-term stability specification is noncumulative. The drift subsequent 1,000 hour periods is significantly lower than in the first 1,000 hour period.

## ADR392—SPECIFICATIONS

Electrical characteristics,  $V_{IN} = 4.3\text{ V to }15\text{ V}$ ,  $T_A = 25^\circ\text{C}$ , unless otherwise noted.

Table 4.

| Parameter                        | Symbol                         | Conditions   | Min   | Typ   | Max   | Unit              |     |    |
|----------------------------------|--------------------------------|--|-------|-------|-------|-------------------|-----|----|
| OUTPUT VOLTAGE                   | $V_O$                          | A Grade  | 4.090 | 4.096 | 4.102 | V                 |     |    |
|                                  | $V_O$                          | B Grade  | 4.091 | 4.096 | 4.101 | V                 |     |    |
| INITIAL ACCURACY                 | $V_{OERR}$                     | A Grade  |       |       | 6     | mV                |     |    |
|                                  | $V_{OERR}$                     | A Grade  |       |       | 0.15  | %                 |     |    |
|                                  | $V_{OERR}$                     | B Grade  |       |       | 5     | mV                |     |    |
|                                  | $V_{OERR}$                     | B Grade  |       |       | 0.12  | %                 |     |    |
| TEMPERATURE COEFFICIENT          | $TCV_O$                        | A Grade, $-40^\circ\text{C} < T_A < +125^\circ\text{C}$  |       |       | 25    | ppm/°C            |     |    |
|                                  |                                | B Grade, $-40^\circ\text{C} < T_A < +125^\circ\text{C}$  |       |       | 9     | ppm/°C            |     |    |
| SUPPLY VOLTAGE HEADROOM          | $V_{IN} - V_O$                 |  | 300   |       |       | mV                |     |    |
| LINE REGULATION                  | $\Delta V_O / \Delta V_{IN}$   | $V_{IN} = 4.3\text{ V to }15\text{ V}$ , $-40^\circ\text{C} < T_A < +125^\circ\text{C}$                          |       | 10    | 25    | ppm/V             |     |    |
| LOAD REGULATION                  | $\Delta V_O / \Delta I_{LOAD}$ | $I_{LOAD} = 0\text{ mA to }5\text{ mA}$ , $-40^\circ\text{C} < T_A < +125^\circ\text{C}$ , $V_{IN} = 5\text{ V}$ |       |       | 140   | ppm/mA            |     |    |
| QUIESCENT CURRENT                | $I_{IN}$                       | No Load  |       |       | 120   | $\mu\text{A}$     |     |    |
|                                  |                                | $-40^\circ\text{C} < T_A < +125^\circ\text{C}$   |       |       | 140   | $\mu\text{A}$     |     |    |
| VOLTAGE NOISE                    | $e_{N\text{ p-p}}$             | 0.1 Hz to 10 Hz  |       | 7     |       | $\mu\text{V p-p}$ |     |    |
| TURN-ON SETTLING TIME            | $t_R$                          |  |       | 20    |       | $\mu\text{s}$     |     |    |
| LONG-TERM STABILITY <sup>1</sup> | $\Delta V_O$                   | 1,000 Hours  |       | 50    |       | ppm               |     |    |
| OUTPUT VOLTAGE HYSTERESIS        | $\Delta V_{O\_HYS}$            |  |       | 100   |       | ppm               |     |    |
| RIPPLE REJECTION RATIO           | RRR                            | $f_{IN} = 60\text{ kHz}$   |       | 80    |       | dB                |     |    |
| SHORT CIRCUIT TO GND             | $I_{SC}$                       | $V_{IN} = 5\text{ V}$  |       | 25    |       | mA                |     |    |
|                                  |                                | $V_{IN} = 15\text{ V}$   |       | 30    |       | mA                |     |    |
| SHUTDOWN PIN                     | $I_{SHDN}$                     |  | 2.4   |       | 3     | $\mu\text{A}$     |     |    |
|                                  |                                |  |       |       |       | $I_{LOGIC}$       | 500 | nA |
|                                  |                                |  |       |       |       | $V_{INL}$         | 0.8 | V  |
|                                  |                                |  |       |       |       | $V_{INH}$         |     | V  |

<sup>1</sup> The long-term stability specification is noncumulative. The drift subsequent 1,000 hour periods is significantly lower than in the first 1,000 hour period.

# ADR390/ADR391/ADR392/ADR395

## ADR395—SPECIFICATIONS

Electrical characteristics,  $V_{IN} = 5.3\text{ V to }15\text{ V}$ ,  $T_A = 25^\circ\text{C}$ , unless otherwise noted.

Table 5.

| Parameter                        | Symbol                         | Conditions  | Min   | Typ   | Max   | Unit                  |
|----------------------------------|--------------------------------|---|-------|-------|-------|-----------------------|
| OUTPUT VOLTAGE                   | $V_O$                          | A Grade   | 4.994 | 5.000 | 5.006 | V                     |
|                                  | $V_O$                          | B Grade   | 4.995 | 5.000 | 5.005 | V                     |
| INITIAL ACCURACY                 | $V_{OERR}$                     | A Grade   |       |       | 6     | mV                    |
|                                  | $V_{OERR}$                     | B Grade   |       |       | 0.12  | %                     |
|                                  | $V_{OERR}$                     | B Grade   |       |       | 5     | mV                    |
|                                  | $V_{OERR}$                     | B Grade   |       |       | 0.10  | %                     |
| TEMPERATURE COEFFICIENT          | $TCV_O$                        | A Grade, $-40^\circ\text{C} < T_A < +125^\circ\text{C}$   |       |       | 25    | ppm/ $^\circ\text{C}$ |
|                                  |                                | B Grade, $-40^\circ\text{C} < T_A < +125^\circ\text{C}$   |       |       | 9     | ppm/ $^\circ\text{C}$ |
| SUPPLY VOLTAGE HEADROOM          | $V_{IN} - V_O$                 |   | 300   |       |       | mV                    |
| LINE REGULATION                  | $\Delta V_O / \Delta V_{IN}$   | $V_{IN} = 4.3\text{ V to }15\text{ V}$ , $-40^\circ\text{C} < T_A < +85^\circ\text{C}$                          |       | 10    | 25    | ppm/V                 |
| LOAD REGULATION                  | $\Delta V_O / \Delta I_{LOAD}$ | $I_{LOAD} = 0\text{ mA to }5\text{ mA}$ , $-40^\circ\text{C} < T_A < +85^\circ\text{C}$ , $V_{IN} = 6\text{ V}$ |       |       | 140   | ppm/mA                |
| QUIESCENT CURRENT                | $I_{IN}$                       | No Load   |       |       | 120   | $\mu\text{A}$         |
|                                  |                                | $-40^\circ\text{C} < T_A < +125^\circ\text{C}$  |       |       | 140   | $\mu\text{A}$         |
| VOLTAGE NOISE                    | $e_{N\text{ p-p}}$             | 0.1 Hz to 10 Hz   |       | 8     |       | $\mu\text{V p-p}$     |
| TURN-ON SETTLING TIME            | $t_R$                          |   |       | 20    |       | $\mu\text{s}$         |
| LONG-TERM STABILITY <sup>1</sup> | $\Delta V_O$                   | 1,000 Hours   |       | 50    |       | ppm                   |
| OUTPUT VOLTAGE HYSTERESIS        | $\Delta V_{O\_HYS}$            |   |       | 100   |       | ppm                   |
| RIPPLE REJECTION RATIO           | RRR                            | $f_{IN} = 60\text{ kHz}$  |       | 80    |       | dB                    |
| SHORT CIRCUIT TO GND             | $I_{SC}$                       | $V_{IN} = 5\text{ V}$   |       | 25    |       | mA                    |
|                                  |                                | $V_{IN} = 15\text{ V}$  |       | 30    |       | mA                    |
| SHUTDOWN PIN                     |                                |   |       |       |       |                       |
| Shutdown Supply Current          | $I_{SHDN}$                     |   |       |       | 3     | $\mu\text{A}$         |
| Shutdown Logic Input Current     | $I_{LOGIC}$                    |   |       |       | 500   | nA                    |
| Shutdown Logic Low               | $V_{INL}$                      |   |       |       | 0.8   | V                     |
| Shutdown Logic High              | $V_{INH}$                      |   | 2.4   |       |       | V                     |

<sup>1</sup> The long-term stability specification is noncumulative. The drift subsequent 1,000 hour periods is significantly lower than in the first 1,000 hour period.

## ABSOLUTE MAXIMUM RATINGS

At 25°C, unless otherwise noted.

Table 6.

| Parameter                                  | Rating              |
|--|---------------------|
| Supply Voltage                             | 18 V                |
| Output Short-Circuit Duration to GND       | See Derating Curves |
| Storage Temperature Range                  | -65°C to +125°C     |
| Operating Temperature Range                | -40°C to +125°C     |
| Junction Temperature Range                 | -65°C to +125°C     |
| Lead Temperature Range (Soldering, 60 sec) | 300°C               |

Stresses above those listed under Absolute Maximum Ratings may cause permanent damage to the device. This is a stress rating only; functional operation of the device at these or any other conditions above those indicated in the operational section of this specification is not implied. Exposure to absolute maximum rating conditions for extended periods may affect device reliability.

### ESD CAUTION

ESD (electrostatic discharge) sensitive device. Electrostatic charges as high as 4000 V readily accumulate on the human body and test equipment and can discharge without detection. Although this product features proprietary ESD protection circuitry, permanent damage may occur on devices subjected to high energy electrostatic discharges. Therefore, proper ESD precautions are recommended to avoid performance degradation or loss of functionality.

### THERMAL RESISTANCE

$\theta_{JA}$  is specified for the worst-case conditions, i.e.,  $\theta_{JA}$  is specified for a device soldered in a circuit board for surface-mount packages.

Table 7. Thermal Resistance

| Package Type     | $\theta_{JA}$ | $\theta_{JC}$ | Unit |
|------------------|---------------|---------------|------|
| TSOT-23-5 (UJ-5) | 230           | 146           | °C/W |



## TERMINOLOGY

### Temperature Coefficient

The change of output voltage with respect to operating temperature changes normalized by the output voltage at 25°C. This parameter is expressed in ppm/°C and can be determined by the following equation:

$$TCV_o [ppm/°C] = \frac{V_o(T_2) - V_o(T_1)}{V_o(25°C) \times (T_2 - T_1)} \times 10^6$$

where:

$$V_o(25°C) = V_o \text{ at } 25°C$$

$$V_o(T_1) = V_o \text{ at Temperature 1}$$

$$V_o(T_2) = V_o \text{ at Temperature 2}$$

### Line Regulation

The change in output voltage due to a specified change in input voltage. This parameter accounts for the effects of self-heating. Line regulation is expressed in either percent per volt, parts-per-million per volt, or microvolts per volt change in input voltage.

### Load Regulation

The change in output voltage due to a specified change in load current. This parameter accounts for the effects of self-heating. Load regulation is expressed in either microvolts per milli-ampere, parts-per-million per milliamperere, or ohms of dc output resistance.

### Long-Term Stability

Typical shift of output voltage at 25°C on a sample of parts subjected to a test of 1,000 hours at 25°C.

$$\Delta V_o = V_o(t_0) - V_o(t_1)$$

$$\Delta V_o [ppm] = \left( \frac{V_o(t_0) - V_o(t_1)}{V_o(t_0)} \times 10^6 \right)$$

where:

$$V_o(t_0) = V_o \text{ at } 25°C \text{ at Time } 0$$

$$V_o(t_1) = V_o \text{ at } 25°C \text{ after 1,000 hours operation at } 25°C$$

### Thermal Hysteresis

The change of output voltage after the device is cycled through temperatures from +25°C to -40°C to +125°C and back to +25°C. This is a typical value from a sample of parts put through such a cycle.

$$V_{o\_HYS} = V_o(25°C) - V_{o\_TC}$$

$$V_{o\_HYS} [ppm] = \frac{V_o(25°C) - V_{o\_TC}}{V_o(25°C)} \times 10^6$$

where:

$$V_o(25°C) = V_o \text{ at } 25°C$$

$$V_{o\_TC} = V_o \text{ at } 25°C \text{ after a temperature cycle from } +25°C \text{ to } -40°C \text{ to } +125°C \text{ and back to } +25°C$$

## NOTES

### Input Capacitor

Input capacitors are not required on the ADR39x. There is no limit for the value of the capacitor used on the input, but a 1 μF to 10 μF capacitor on the input will improve transient response in applications where the supply suddenly changes. An additional 0.1 μF in parallel will also help reduce noise from the supply.

### Output Capacitor

The ADR39x does not require output capacitors for stability under any load condition. An output capacitor, typically 0.1 μF, will filter out any low level noise voltage and will not affect the operation of the part. On the other hand, the load transient response can improve with an additional 1 μF to 10 μF output capacitor in parallel. A capacitor here will act as a source of stored energy for a sudden increase in load current. The only parameter that will degrade by adding an output capacitor is the turn-on time, and it depends on the size of the capacitor chosen.

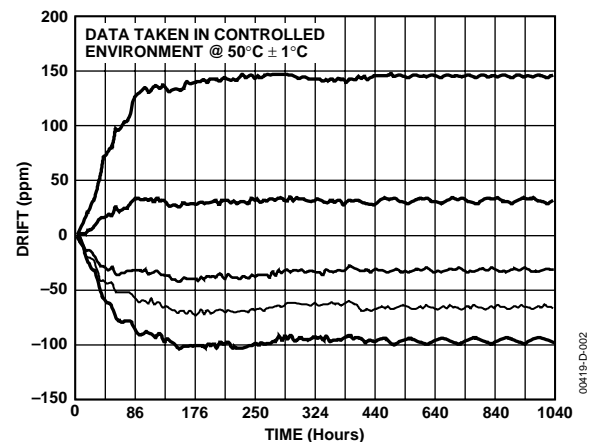

Figure 2. ADR391 Typical Long-Term Drift over 1,000 Hours



# TYPICAL PERFORMANCE CHARACTERISTICS

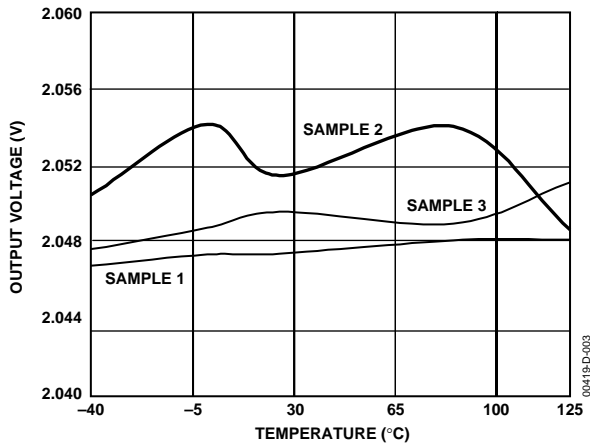

Figure 3. ADR390 Output Voltage vs. Temperature

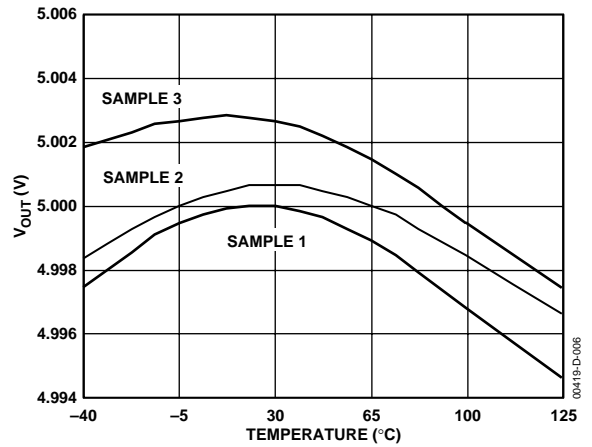

Figure 6. ADR395 Output Voltage vs. Temperature

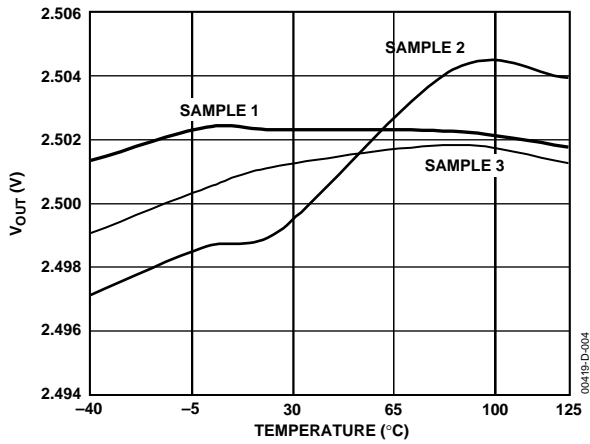

Figure 4. ADR391 Output Voltage vs. Temperature

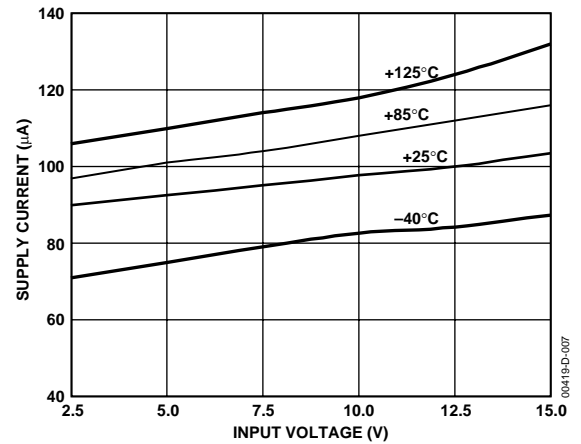

Figure 7. ADR390 Supply Current vs. Input Voltage

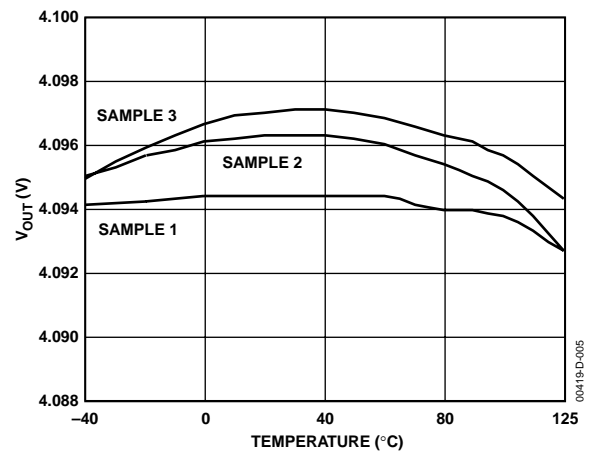

Figure 5. ADR392 Output Voltage vs. Temperature

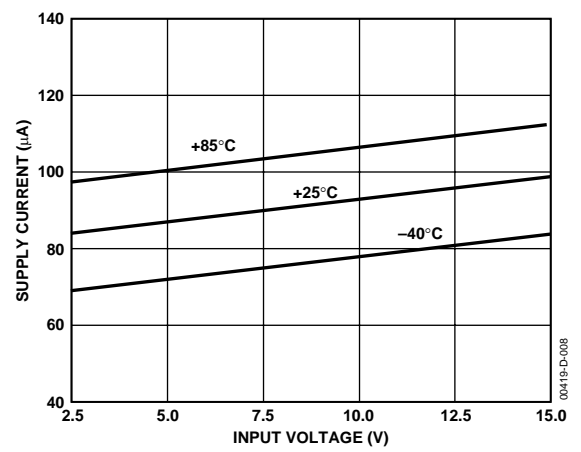

Figure 8. ADR391 Supply Current vs. Input Voltage

# ADR390/ADR391/ADR392/ADR395

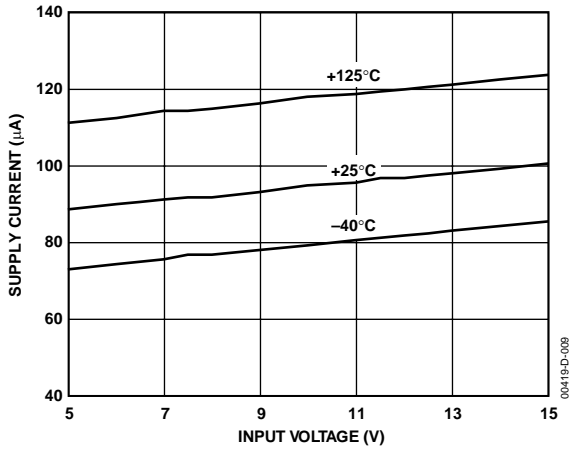

Figure 9. ADR392 Supply Current vs. Input Voltage

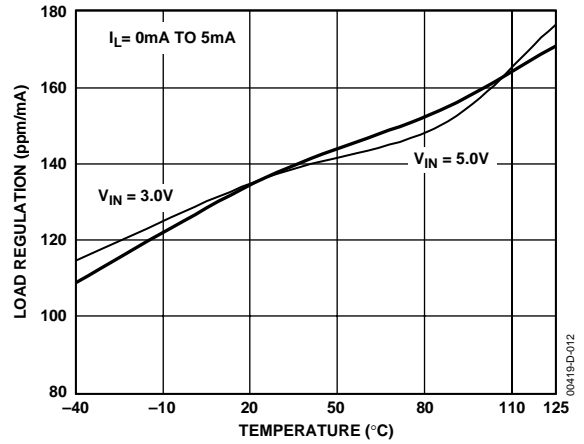

Figure 12. ADR391 Load Regulation vs. Temperature

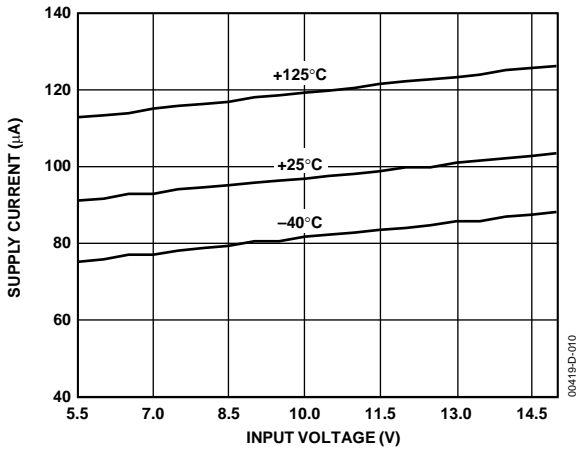

Figure 10. ADR395 Supply Current vs. Input Voltage

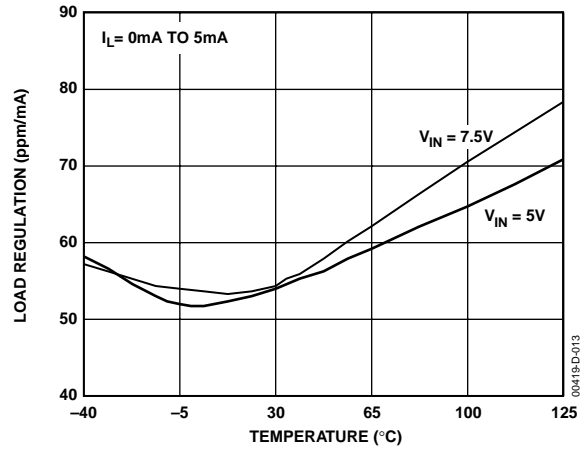

Figure 13. ADR392 Load Regulation vs. Temperature

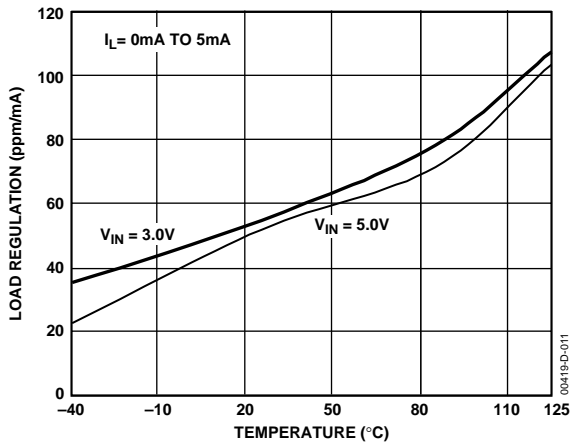

Figure 11. ADR390 Load Regulation vs. Temperature

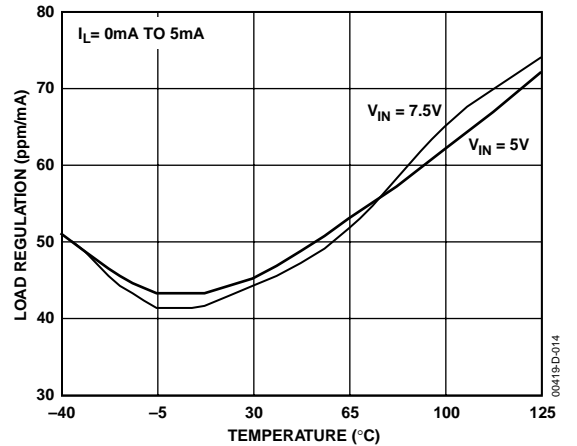

Figure 14. ADR395 Load Regulation vs. Temperature

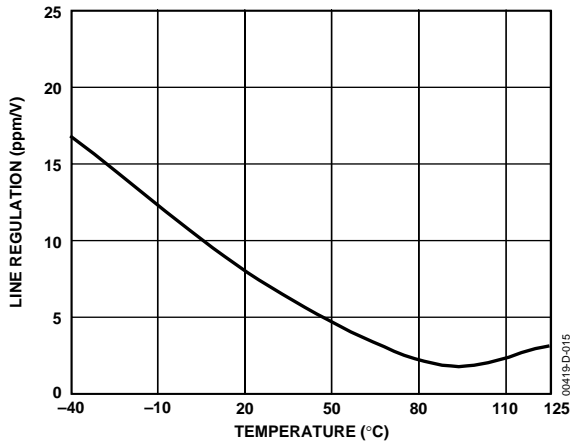

Figure 15. ADR390 Line Regulation vs. Temperature

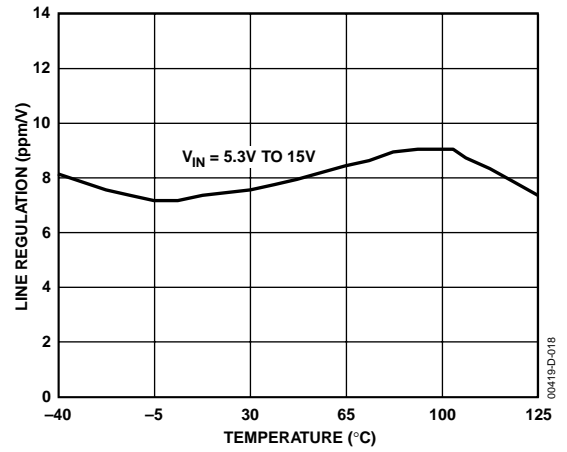

Figure 18. ADR395 Line Regulation vs. Temperature

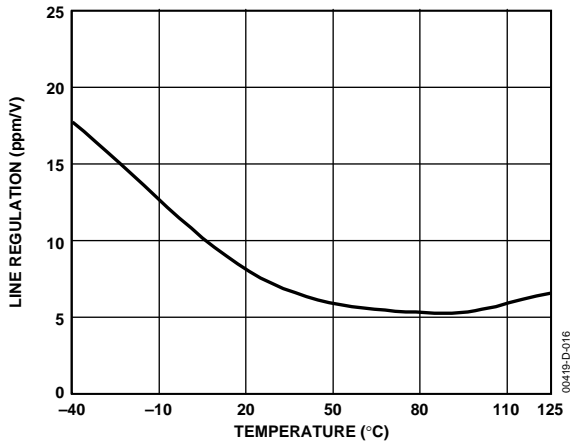

Figure 16. ADR391 Line Regulation vs. Temperature

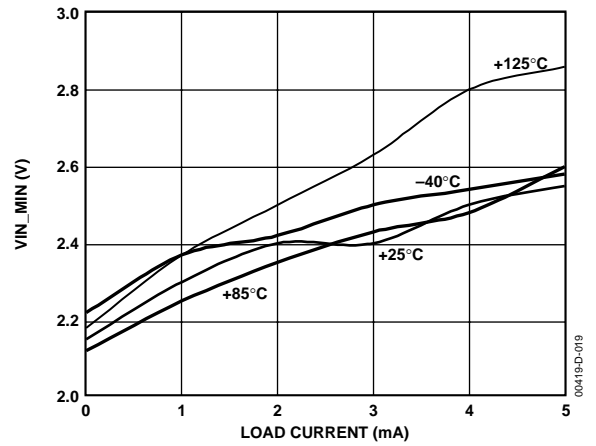

Figure 19. ADR390 Minimum Input Voltage vs. Load Current

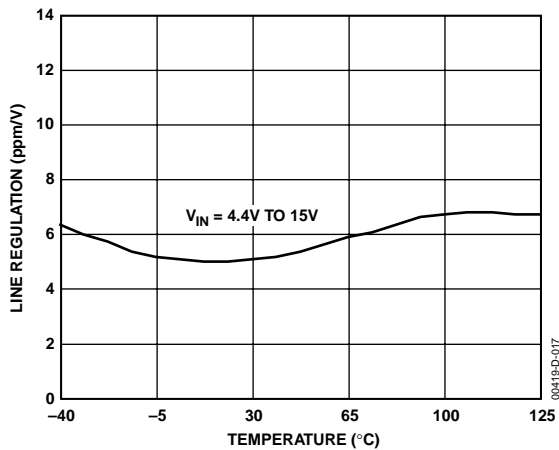

Figure 17. ADR392 Line Regulation vs. Temperature

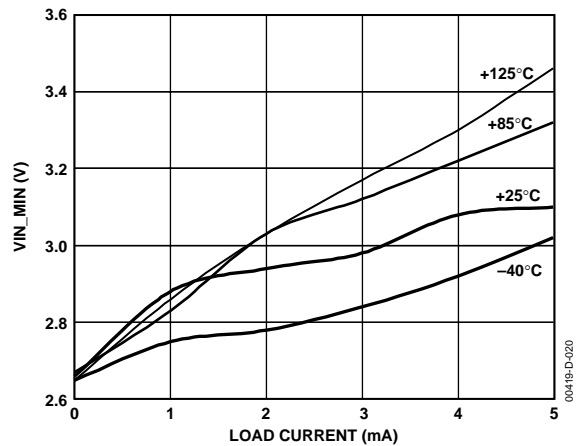

Figure 20. ADR391 Minimum Input Voltage vs. Load Current

# ADR390/ADR391/ADR392/ADR395

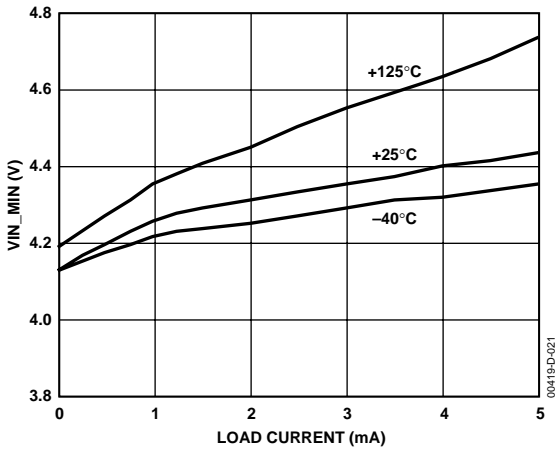

Figure 21. ADR392 Minimum Input Voltage vs. Load Current

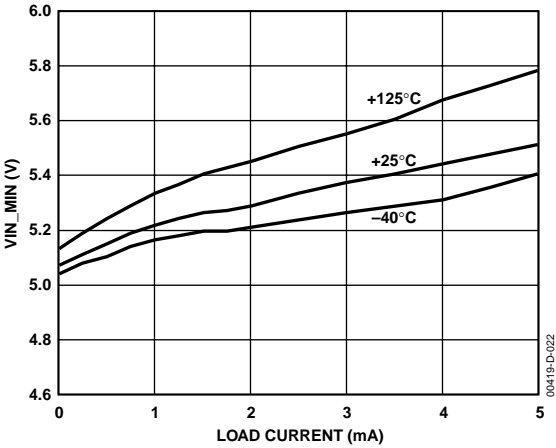

Figure 22. ADR395 Minimum Input Voltage vs. Load Current

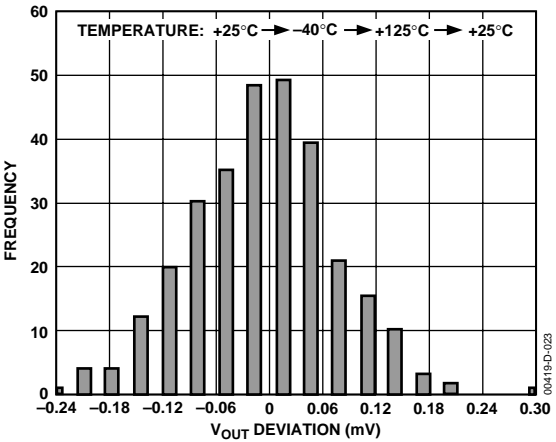

Figure 23. ADR390  $V_{OUT}$  Hysteresis Distribution

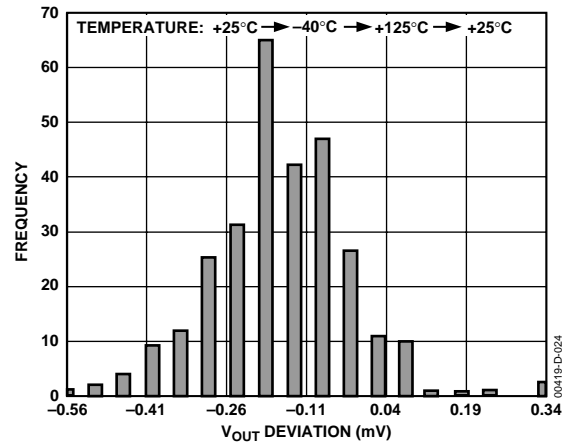

Figure 24. ADR391  $V_{OUT}$  Hysteresis Distribution

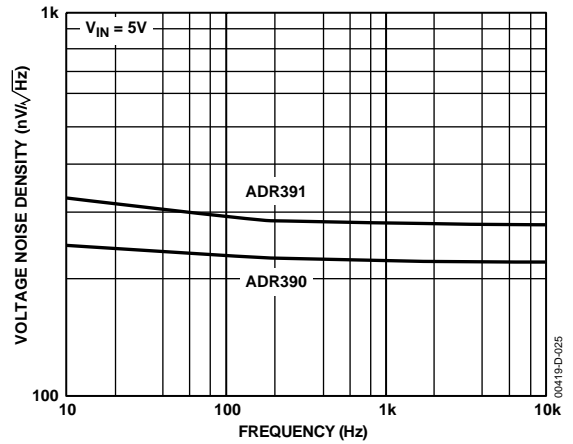

Figure 25. Voltage Noise Density vs. Frequency

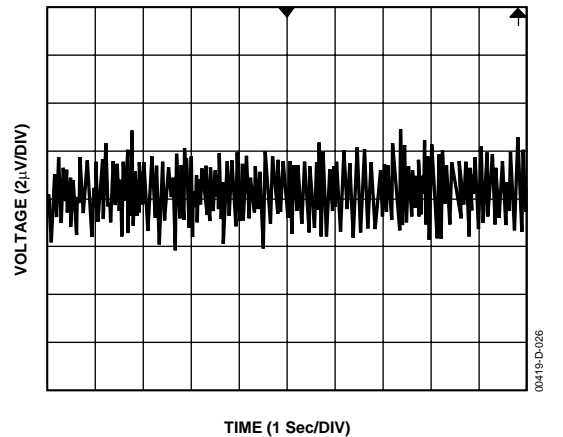

Figure 26. ADR391 Typical Voltage Noise 0.1 Hz to 10 Hz

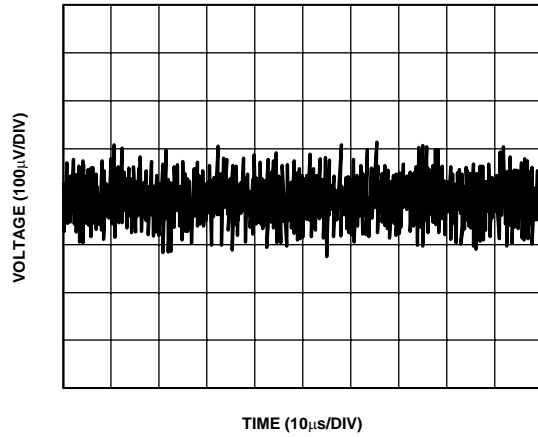

Figure 27. ADR391 Voltage Noise 10 Hz to 10 kHz

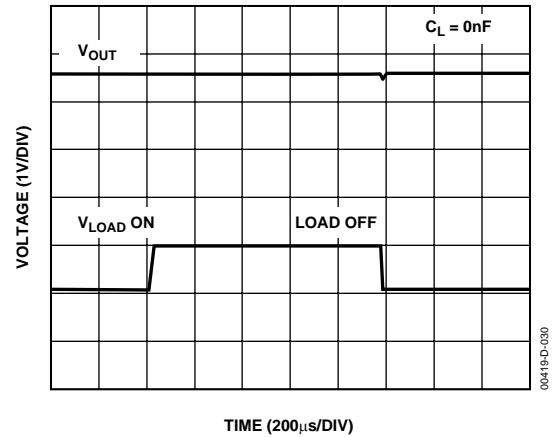

Figure 30. ADR391 Load Transient Response

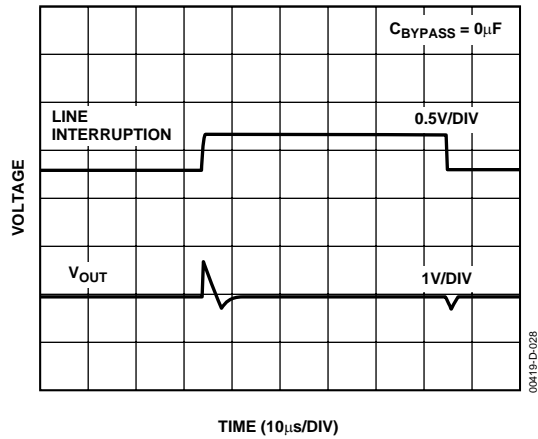

Figure 28. ADR391 Line Transient Response

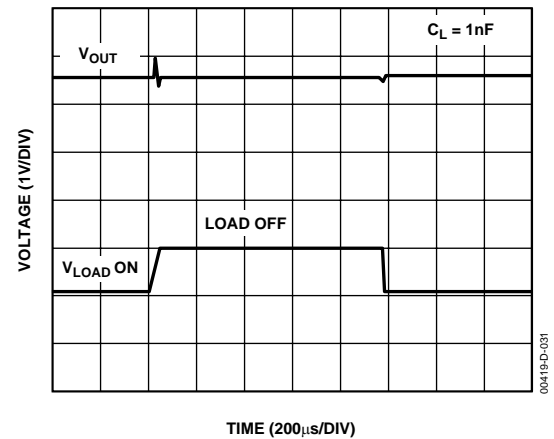

Figure 31. ADR391 Load Transient Response

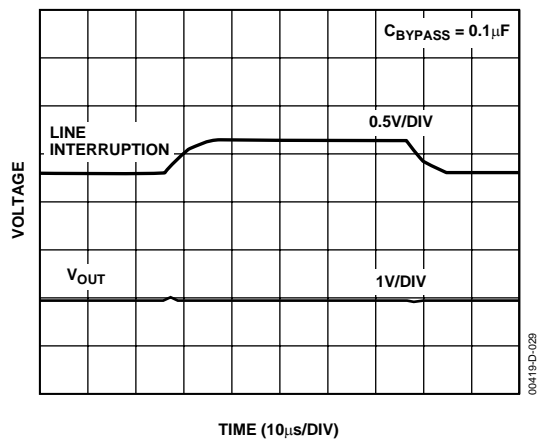

Figure 29. ADR391 Line Transient Response

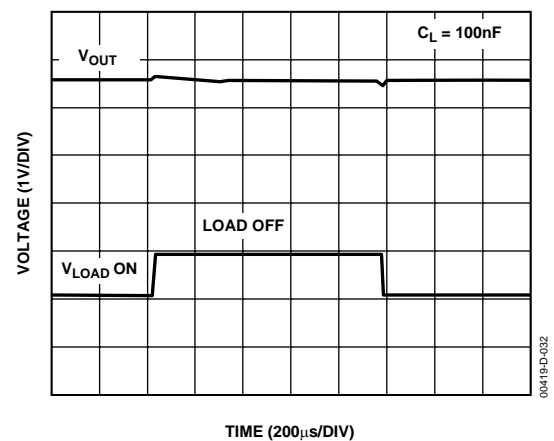
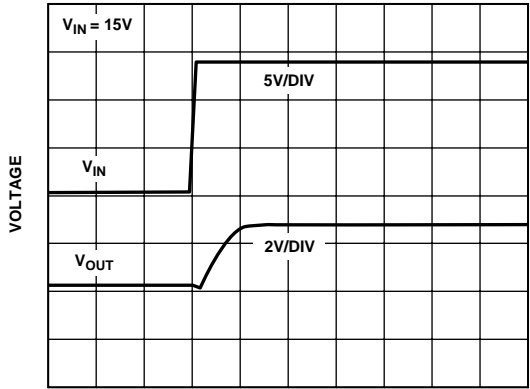

Figure 32. ADR391 Load Transient Response

# ADR390/ADR391/ADR392/ADR395



TIME (20 μs/DIV)

Figure 33. ADR391 Turn-On Response Time at 15 V

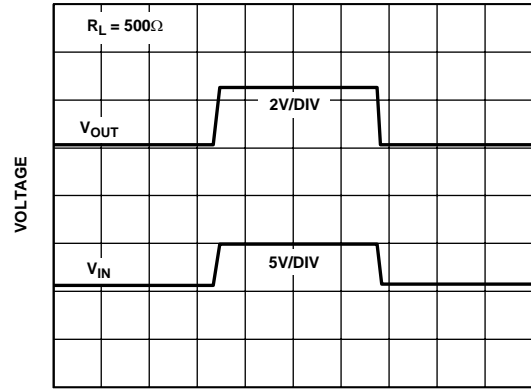

TIME (200 μs/DIV)

Figure 36. ADR391 Turn-On/Turn-Off Response at 5 V

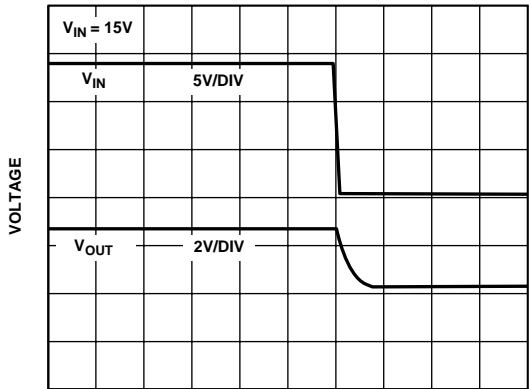

TIME (40 μs/DIV)

Figure 34. ADR391 Turn-Off Response at 15 V

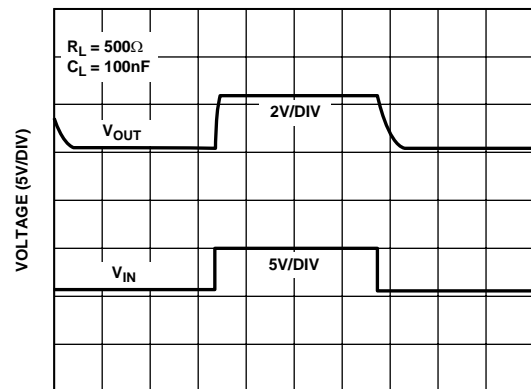

TIME (200 μs/DIV)

Figure 37. ADR391 Turn-On/Turn-Off Response at 5 V

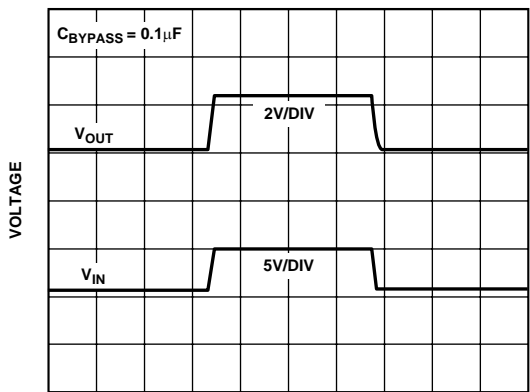

TIME (200 μs/DIV)

Figure 35. ADR391 Turn-On/Turn-Off Response at 5 V

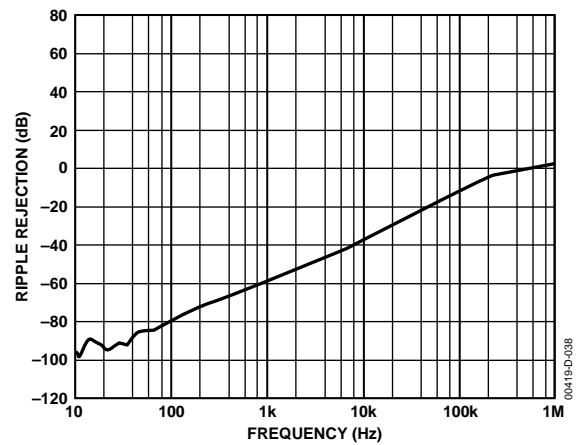

Figure 38. Ripple Rejection vs. Frequency

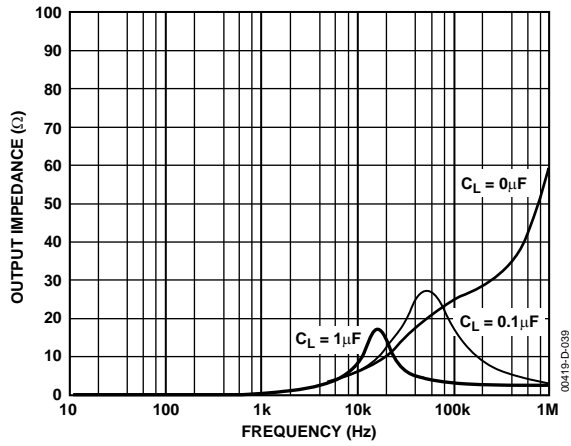

Figure 39. Output Impedance vs. Frequency

## THEORY OF OPERATION

Band gap references are the high performance solution for low supply voltage and low power voltage reference applications, and the ADR390/ADR391/ADR392/ADR395 are no exception. The uniqueness of these devices lies in the architecture. As shown in Figure 40, the ideal zero TC band gap voltage is referenced to the output, not to ground. Therefore, if noise exists on the ground line, it will be greatly attenuated on  $V_{OUT}$ . The band gap cell consists of the PNP pair, Q51 and Q52, running at unequal current densities. The difference in  $V_{BE}$  results in a voltage with a positive TC, which is amplified by a ratio of

$$2 \times \frac{R58}{R54}$$

This PTAT voltage, combined with  $V_{BE}$ s of Q51 and Q52, produces a stable band gap voltage.

Reduction in the band gap curvature is performed by the ratio of the resistors R44 and R59, one of which is linearly temperature dependent. Precision laser trimming and other patented circuit techniques are used to further enhance the drift performance.

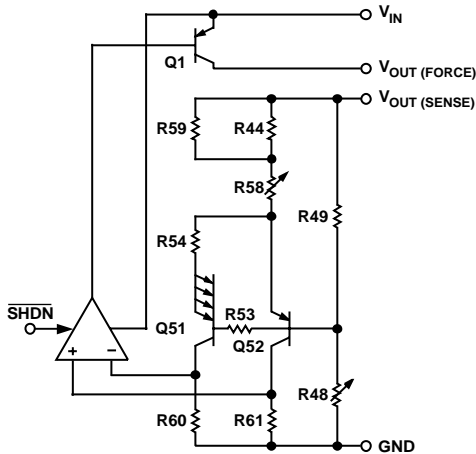

Figure 40. Simplified Schematic

### Device Power Dissipation Considerations

The ADR390/ADR391/ADR392/ADR395 are capable of delivering load currents to 5 mA with an input voltage that ranges from 2.8 V (ADR391 only) to 15 V. When these devices are used in applications with large input voltages, care should be taken to avoid exceeding the specified maximum power dissipation or junction temperature because it could result in premature device failure. The following formula should be used to calculate a device's maximum junction temperature or dissipation:

$$P_D = \frac{T_J - T_A}{\theta_{JA}}$$

In this equation,  $T_J$  and  $T_A$  are, respectively, the junction and ambient temperatures,  $P_D$  is the device power dissipation, and  $\theta_{JA}$  is the device package thermal resistance.

### Shutdown Mode Operation

The ADR390/ADR391/ADR392/ADR395 include a shutdown feature that is TTL/CMOS level compatible. A Logic Low or a zero volt condition on the  $\overline{SHDN}$  pin is required to turn the devices off. During shutdown, the output of the reference becomes a high impedance state where its potential would then be determined by external circuitry. If the shutdown feature is not used, the  $\overline{SHDN}$  pin should be connected to  $V_{IN}$  (Pin 2).



# APPLICATIONS

## BASIC VOLTAGE REFERENCE CONNECTION

The circuit shown in Figure 41 illustrates the basic configuration for the ADR39x family. Decoupling capacitors are not required for circuit stability. The ADR39x family is capable of driving capacitive loads from 0  $\mu$ F to 10  $\mu$ F. However, a 0.1  $\mu$ F ceramic output capacitor is recommended to absorb and deliver the charge as required by a dynamic load.

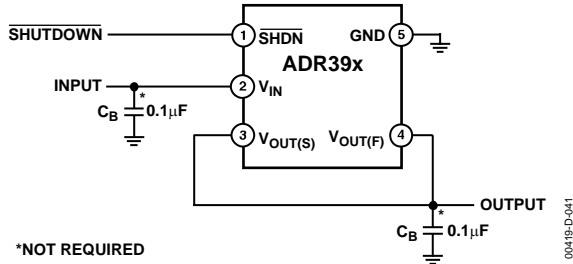

Figure 41. Basic Configuration for the ADR39x Family

## Stacking Reference ICs for Arbitrary Outputs

Some applications may require two reference voltage sources, which are a combined sum of standard outputs. Figure 42 shows how this “stacked output” reference can be implemented.

| U1/U2         | V <sub>OUT1</sub> (V) | V <sub>OUT2</sub> (V) |
|---------------|-----------------------|-----------------------|
| ADR390/ADR390 | 2.048                 | 4.096                 |
| ADR391/ADR391 | 2.5                   | 5.0                   |
| ADR392/ADR392 | 4.096                 | 8.192                 |
| ADR395/ADR395 | 5                     | 10                    |

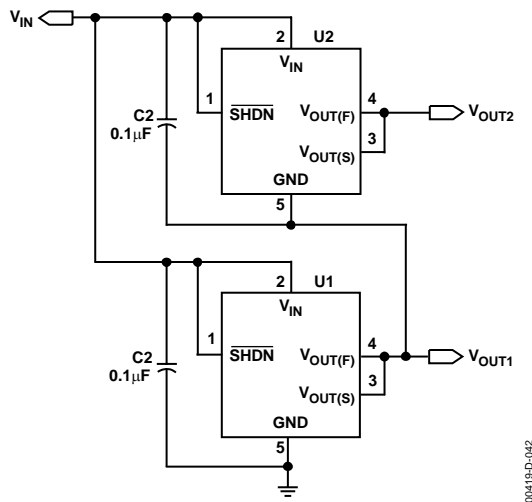

Figure 42. Stacking Voltage References with the ADR390/ADR391/ADR392/ADR395

Two reference ICs are used, fed from an unregulated input,  $V_{IN}$ . The outputs of the individual ICs are simply connected in series, which provides two output voltages,  $V_{OUT1}$  and  $V_{OUT2}$ .  $V_{OUT1}$  is the terminal voltage of U1, while  $V_{OUT2}$  is the sum of this voltage and the terminal voltage of U2. U1 and U2 are simply chosen for the two voltages that supply the required outputs (see the Output Table in Figure 42). For example, if both U1 and U2 are ADR391s,  $V_{OUT1}$  is 2.5 V and  $V_{OUT2}$  is 5.0 V.

While this concept is simple, a precaution is in order. Since the lower reference circuit must sink a small bias current from U2 plus the base current from the series PNP output transistor in U2, either the external load of U1 or R1 must provide a path for this current. If the U1 minimum load is not well defined, the R1 resistor should be used and set to a value that will conservatively pass 600  $\mu$ A of current with the applicable  $V_{OUT1}$  across it. Note that the two U1 and U2 reference circuits are treated locally as macrocells; each has its own bypasses at input and output for best stability. Both U1 and U2 in this circuit can source dc currents up to their full rating. The minimum input voltage,  $V_{IN}$ , is determined by the sum of the outputs,  $V_{OUT2}$ , plus the dropout voltage of U2.

## A Negative Precision Reference without Precision Resistors

A negative reference can be easily generated by adding an op amp, A1, and is configured as shown in Figure 43.  $V_{OUTF}$  and  $V_{OUTS}$  are at virtual ground and, therefore, the negative reference can be taken directly from the output of the op amp. The op amp must be dual-supply, low offset, and rail-to-rail if the negative supply voltage is close to the reference output.

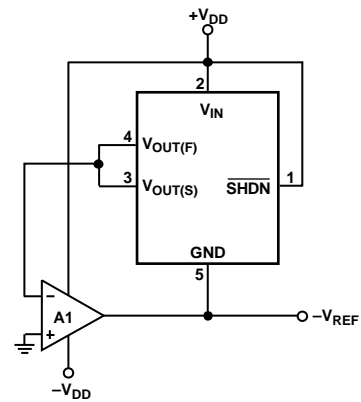

Figure 43. Negative Reference

# ADR390/ADR391/ADR392/ADR395

## General-Purpose Current Source

Many times in low power applications, the need arises for a precision current source that can operate on low supply voltages. ADR390/ADR391/ADR392/ADR395 can be configured as a precision current source. As shown in Figure 45, the circuit configuration is a floating current source with a grounded load. The reference's output voltage is bootstrapped across  $R_{SET}$ , which sets the output current into the load. With this configuration, circuit precision is maintained for load currents in the range from the reference's supply current, typically 90  $\mu$ A to approximately 5 mA.

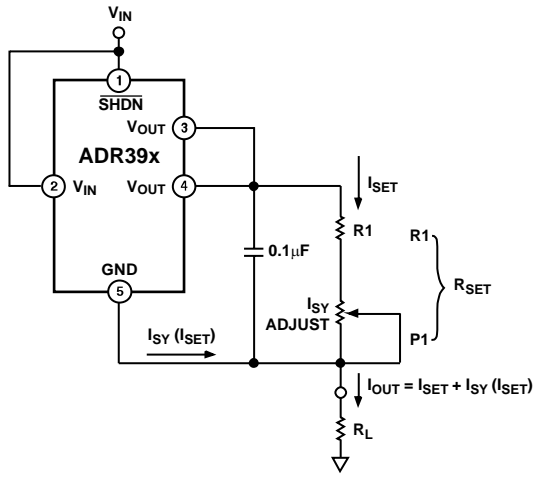

Figure 44. A General-Purpose Current Source

## High Power Performance with Current Limit

In some cases, the user may want higher output current delivered to a load and still achieve better than 0.5% accuracy out of the ADR39x. The accuracy for a reference is normally specified on the data sheet with no load. However, the output voltage changes with load current.

The circuit in Figure 45 provides high current without compromising the accuracy of the ADR39x. The series pass transistor Q1 provides up to 1 A load current. The ADR39x delivers only the base drive to Q1 through the force pin. The sense pin of the ADR39x is a regulated output and is connected to the load.

The transistor Q2 protects Q1 during short-circuit limit faults by robbing its base drive. The maximum current is

$$I_{LMAX} \approx 0.6 V/R_S$$

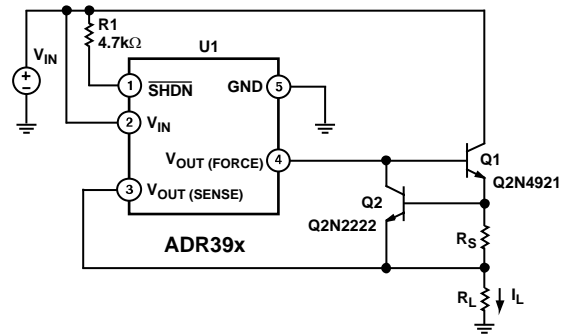

Figure 45. ADR39x for High Power Performance with Current Limit

A similar circuit function can also be achieved with the Darlington transistor configuration, as shown in see Figure 46.

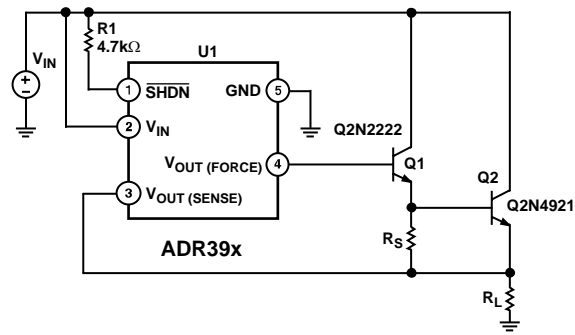
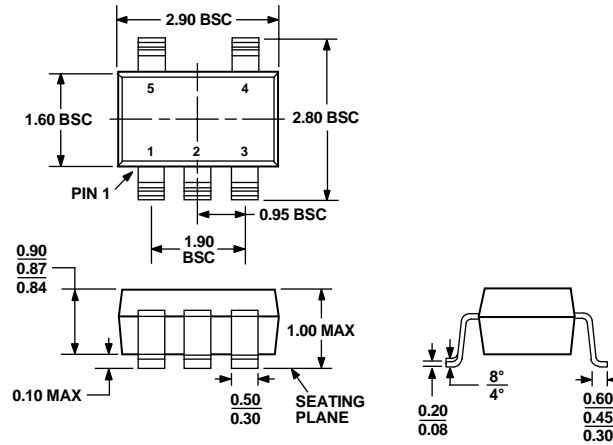

Figure 46. ADR39x for High Output Current with Darlington Drive Configuration

OUTLINE DIMENSIONS



COMPLIANT TO JEDEC STANDARDS MO-193AB

Figure 47. 5-Lead Thin Small Outline Transistor Package [TSOT] (UJ-5)  
Dimensions shown in millimeters

ORDERING GUIDE

| Models                        | Output Voltage (Vo) | Initial Accuracy (mV) (%) |      | Temperature Coefficient (ppm/°C) | Package Description | Package Option | Branding | Number of Parts per Reel | Temperature Range |
|-------------------------------|---------------------|---------------------------|------|----------------------------------|---------------------|----------------|----------|--------------------------|-------------------|
| ADR390AUJZ-REEL7 <sup>1</sup> | 2.048               | 6                         | 0.29 | 25                               | TSOT                | UJ-5           | R0A      | 3,000                    | -40°C to +125°C   |
| ADR390AUJZ-R2 <sup>1</sup>    | 2.048               | 6                         | 0.29 | 25                               | TSOT                | UJ-5           | R0A      | 250                      | -40°C to +125°C   |
| ADR390BUJZ-REEL7 <sup>1</sup> | 2.048               | 4                         | 0.19 | 9                                | TSOT                | UJ-5           | R0B      | 3,000                    | -40°C to +125°C   |
| ADR390BUJZ-R2 <sup>1</sup>    | 2.048               | 4                         | 0.19 | 9                                | TSOT                | UJ-5           | R0B      | 250                      | -40°C to +125°C   |
| ADR391AUJZ-REEL7 <sup>1</sup> | 2.5                 | 6                         | 0.24 | 25                               | TSOT                | UJ-5           | R1A      | 3,000                    | -40°C to +125°C   |
| ADR391AUJZ-R2 <sup>1</sup>    | 2.5                 | 6                         | 0.24 | 25                               | TSOT                | UJ-5           | R1A      | 250                      | -40°C to +125°C   |
| ADR391BUJZ-REEL7 <sup>1</sup> | 2.5                 | 4                         | 0.16 | 9                                | TSOT                | UJ-5           | R1B      | 3,000                    | -40°C to +125°C   |
| ADR391BUJZ-R2 <sup>1</sup>    | 2.5                 | 4                         | 0.16 | 9                                | TSOT                | UJ-5           | R1B      | 250                      | -40°C to +125°C   |
| ADR392AUJZ-REEL7 <sup>1</sup> | 4.096               | 6                         | 0.15 | 25                               | TSOT                | UJ-5           | RCA      | 3,000                    | -40°C to +125°C   |
| ADR392AUJZ-R2 <sup>1</sup>    | 4.096               | 6                         | 0.15 | 25                               | TSOT                | UJ-5           | RCA      | 250                      | -40°C to +125°C   |
| ADR392BUJZ-REEL7 <sup>1</sup> | 4.096               | 5                         | 0.12 | 9                                | TSOT                | UJ-5           | RCB      | 3,000                    | -40°C to +125°C   |
| ADR392BUJZ-R2 <sup>1</sup>    | 4.096               | 5                         | 0.12 | 9                                | TSOT                | UJ-5           | RCB      | 250                      | -40°C to +125°C   |
| ADR395AUJZ-REEL7 <sup>1</sup> | 5.0                 | 6                         | 0.12 | 25                               | TSOT                | UJ-5           | RDA      | 3,000                    | -40°C to +125°C   |
| ADR395AUJZ-R2 <sup>1</sup>    | 5.0                 | 6                         | 0.12 | 25                               | TSOT                | UJ-5           | RDA      | 250                      | -40°C to +125°C   |
| ADR395BUJZ-REEL7 <sup>1</sup> | 5.0                 | 5                         | 0.10 | 9                                | TSOT                | UJ-5           | RDB      | 3,000                    | -40°C to +125°C   |
| ADR395BUJZ-R2 <sup>1</sup>    | 5.0                 | 5                         | 0.10 | 9                                | TSOT                | UJ-5           | RDB      | 250                      | -40°C to +125°C   |

<sup>1</sup> Z = Pb-free part.

**NOTES**